

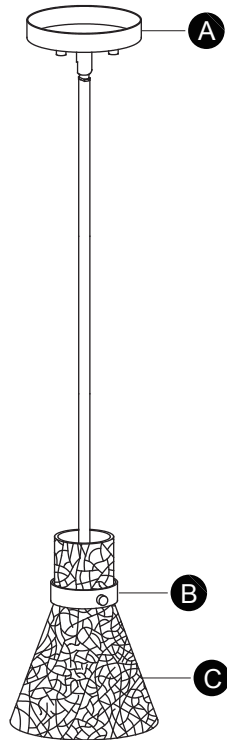

Questions, problems, missing parts?

Before returning to your retailer, call our customer service at 1-800-887-6326
Monday – Friday 9:00 a.m. – 5:00 p.m. CST

PACKAGE CONTENTS



HARDWARE CONTENTS

Note: Hardware not shown actual size.

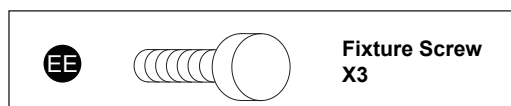
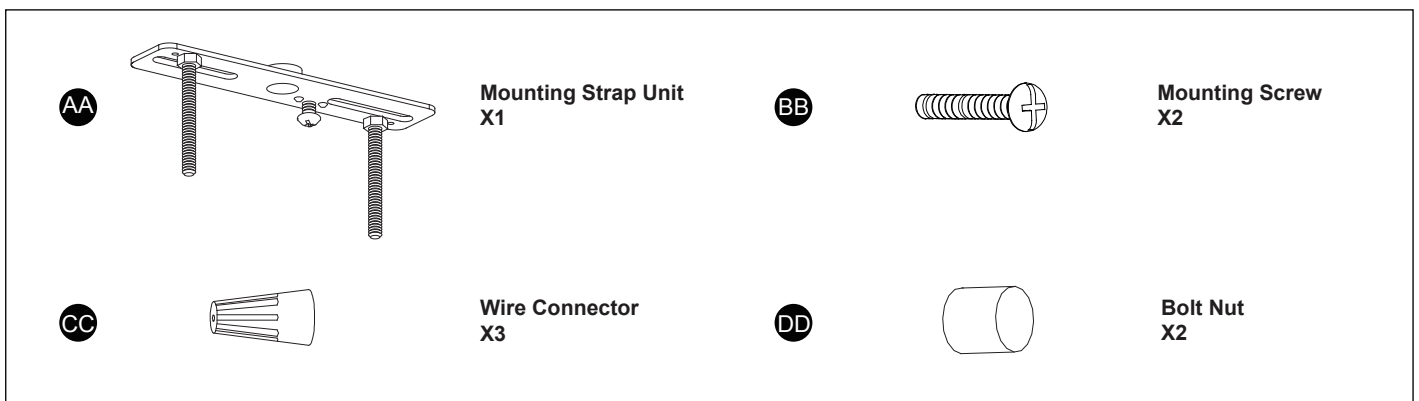

SAFETY INFORMATION

Please read and understand this entire manual before attempting to assemble, operate or install the product.

WARNING

- Turn off electricity at main fuse box (or circuit breaker box) before beginning installation by removing fuse (or switching off circuit breaker).
- Be careful not to damage or cut the wire insulation (covering) during fixture installation. Do not permit wires to contact any surface having a sharp edge. To do so may damage or cut the wire insulation, which could cause serious injury or death from electric shock.

CAUTION

- All electrical connections must be in agreement with local codes, ordinances or the national electric code (NEC). Contact your municipal building department to learn about your local codes, permits and/or inspections.
- Risk of fire – most dwellings built before 1985 have supply wire rated for 140°F/60°C. Consult a qualified electrician before installation.
- Do not connect this fixture to an electrical system that does not provide a means for equipment grounding. Never use a fixture in a two-wire system that is not grounded. If you are not sure your lighting system has a grounding means, do not attempt to install this fixture. Contact a qualified, licensed electrician for information with regards to proper grounding methods as required by the local electrical code in your area.

PREPARATION

Before beginning assembly, installation or operation of product, make sure all parts are present. Compare parts with package contents list and diagram on previous page. If any part is missing or damaged, do not attempt to assemble, install or operate the product. Contact customer service for replacement parts.

Tools Required for Assembly (not included): Slotted Screwdriver, Phillips Screwdriver, Pliers, Electrical Tape, Wire Cutters, Safety Glasses, Ladder, Wire Stripper.

ASSEMBLY INSTRUCTIONS

Turn off the power at the fuse or circuit box.

1. Attach mounting strap unit(AA) to outlet box by using two mounting screws(BB).

Note: The depth of threaded pipe on the mounting strap unit(AA) may need to be adjusted to properly fit the fixture.

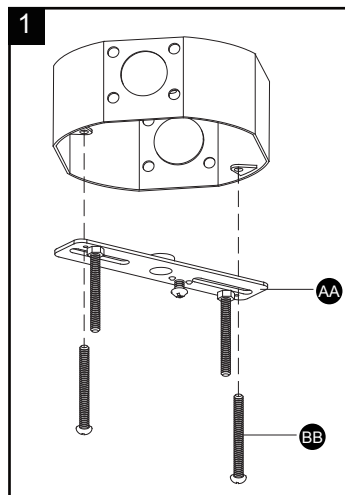

2. Rod connection:

Thread the fixture wires from the fixture through the lower rod, then secure the lower rod onto the glass holder using the threaded pipe.

Thread the fixture wires from the fixture through the middle rod, then secure the middle rod onto the lower rod using the threaded pipe.

Thread the fixture wires from the fixture through the upper rod, then secure the upper rod onto the middle rod using the threaded pipe.

Thread the fixture wires from the fixture through canopy unit(A), then secure the canopy unit(A) onto the upper rod using the threaded pipe.

Note: The fixture height can be adjusted to 35-3/4" by using the rods. Use fewer rods if shorter height is desired.

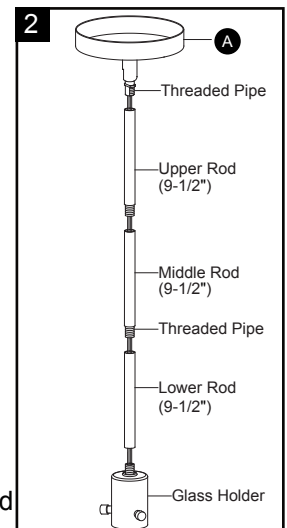

ASSEMBLY INSTRUCTIONS (continued)

3. Pull out the source wires from the outlet box, make wire connections using wire connectors(CC) as follows:

---Connect the black(hot) wire from the fixture to the black (hot) wire from the power source.

---Connect the white(neutral) wire from the fixture to the white(neutral) wire from the power source.

---Attach the fixture ground wire(bare wire) to the mounting strap unit(AA) with the green ground screw, then connect fixture ground wire to the house ground wire with a wire connector(CC).

Carefully put the wires back into the outlet box.

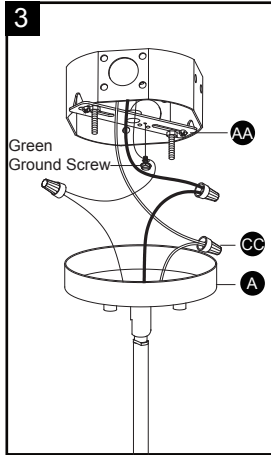

4. Attach the canopy unit (A) to the mounting strap unit(AA), then secure the canopy unit (A) with two bolt nuts (DD).

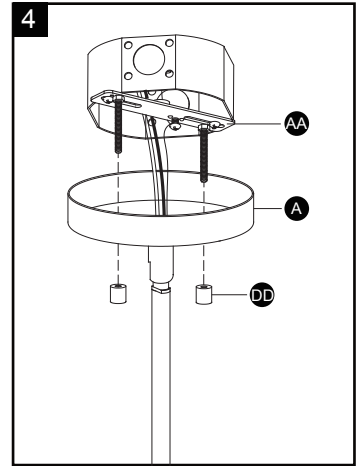

5. Attach the metal ring (B) and glass shade (C) to the glass holder, and align holes of glass shade(C) and metal ring(B) to the glass holder, then secure them with fixture screws (EE).

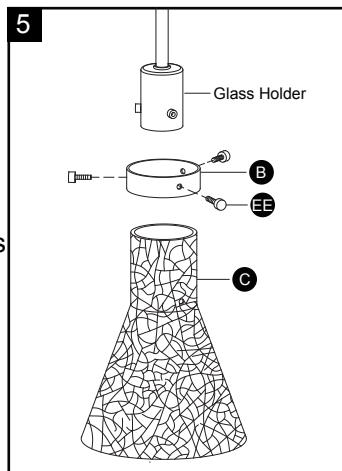

6. Install 1x60W medium base bulb(Type T or ST, not included).



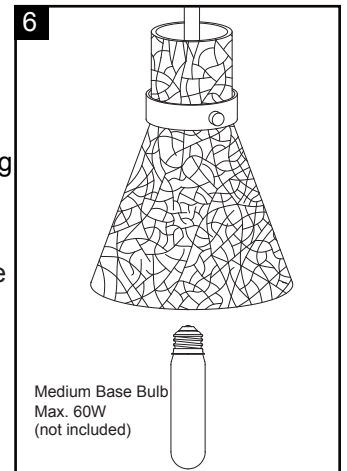

See relamping label at socket area or packaging for maximum allowed wattage.

Turn on the power at the fuse or circuit box.

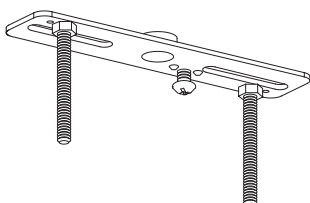
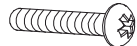
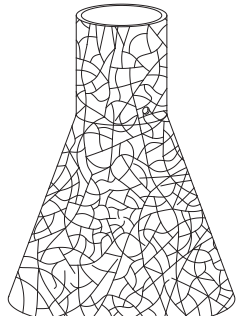

The following parts are available for reorder if damaged or missing. Call our toll free at 1-800-887-6326.

Spare Parts List:

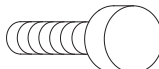
| | | | | | | |
|---|-----------|-------------------------------|---|-----------|-----------------------------|--|
|  | AA | Mounting Strap Unit X1 |  | BB | Mounting Screw X2 |  <p>Assembly Kit 6418MM(1 SET)</p> |
|  | CC | Wire Connector X3 |  | DD | Bolt Nut X2 | |
|  | | 9-1/2" Rod 3299RD |  | EE | Fixture Screw 6426FS | |
| | | | C | | Glass Shade 10269SC | |

CARE AND MAINTENANCE

- To clean, turn off and wipe with a damp, non-abrasive cloth.

TROUBLESHOOTING

1) The light does not work:

- a) Make sure the wall switch and circuit breaker are on.
- b) Make sure the wiring is correct.

2) Fuse blows or circuit trips when light is turned on.

Check for crossed wires, ensure wiring is correct.

If unable to fix any of the above issues, please consult a certified electrician.

FIVE-YEAR LIMITED WARRANTY: If, during normal use, this PATRIOT LIGHTING® lighting fixture breaks or fails due to a defect in material workmanship within five (5) years from the date of original purchase, simply bring this lighting fixture with the original sales receipt back to your nearest MENARDS® retail store. At its discretion, PATRIOT LIGHTING® agrees to have the product or any defective part(s) repaired or replaced with the same or similar PATRIOT LIGHTING® product or part free of charge, within the stated warranty period, when returned by the original purchaser with original sales receipt. This warranty; (1) excludes expendable parts including but not limited to light bulbs; (2) does not cover damage that has resulted from abuse or misuse; and (3) does not cover any losses, labor, injuries to persons/property or costs. This warranty does give you specific legal rights and you may have other rights, which vary from state to state.



Questions, problems, missing parts?

Before returning to your retailer, call our customer service at 1-800-887-6326
Monday – Friday 9:00 a.m. – 5:00 p.m. CST