



PROPANE CONSTRUCTION HEATER

USER'S MANUAL AND OPERATING INSTRUCTIONS

Dyna-Glo™ DELUX MODELS:
LPFA43DGD/LPFA43DGD-01
(37,000/43,000 BTU/HR, FORCED - AIR)

Dyna-Glo™ Pro MODELS:
LPFA43H/LPFA43H-01
(37,000/43,000 BTU/HR, FORCED - AIR)



C US

ANS Z83.7-2017 CSA 2.14-2017
CONSTRUCTION HEATER



Adequate ventilation must be provided.



GHP Group, Inc.
6440 W Howard St
Niles, IL 60714-3302



LPFA43DGD/LPFA43DGD-01



GENERAL HAZARD WARNING

FAILURE TO COMPLY WITH THE PRECAUTIONS AND INSTRUCTIONS PROVIDED WITH THIS HEATER, CAN RESULT IN DEATH, SERIOUS BODILY INJURY AND PROPERTY LOSS, OR DAMAGE FROM HAZARDS OF FIRE, EXPLOSION, BURN, ASPHYXIATION, CARBON MONOXIDE POISONING, AND/OR ELECTRICAL SHOCK.

ONLY PERSONS WHO CAN UNDERSTAND AND FOLLOW THE INSTRUCTIONS SHOULD USE OR SERVICE THIS HEATER.

IF YOU NEED ASSISTANCE OR HEATER INFORMATION SUCH AS AN INSTRUCTION MANUAL, LABEL, ETC; CONTACT THE MANUFACTURER.

CONSUMER: Retain this manual for future reference.

Questions, problems, missing parts? Before returning to your retailer, call our customer service department at 877-447-4768 8:30 a.m. – 4:30 pm CST, Monday – Friday or email us at customerservice@ghpgroupinc.com

www.ghpgroupinc.com

Printed in China

IMLPF43DG - KFV



PROPANE CONSTRUCTION HEATER

TABLE OF CONTENTS

- Introduction & Specifications 2 - 3
- General Safety Instructions 4
- Product Features 4
- Unpacking Heater 5
- Size & Capacity Of Propane Cylinders 6
- Installation To The Propane Gas Tank 7
- Refilling The Propane Gas Tank 7
- Leak Checking & Positioning Heater 8
- Lighting & Shutdown Instructions 8 - 9
- Test Firing Heater & Storage 9
- Troubleshooting 10
- Wiring Diagrams 11
- PROPANE CONSTRUCTION HEATER ILLUSTRATED / PARTS BREAKDOWN:
- FA43 SERIES 12
- Replacement Parts List 13
- Warranty 14 - 15

⚠ WARNING: FIRE, BURN, INHALATION, AND EXPLOSION HAZARD. KEEP SOLID COMBUSTIBLES, SUCH AS BUILDING MATERIALS, PAPER, OR CARDBOARD, A SAFE DISTANCE AWAY FROM THE HEATER AS RECOMMENDED BY THE INSTRUCTIONS.

NEVER USE THE HEATER IN SPACES WHICH DO OR MAY CONTAIN VOLATILE OR AIRBORNE COMBUSTIBLES, OR PRODUCTS SUCH AS GASOLINE, SOLVENTS, PAINT THINNER, DUST PARTICLES OR UNKNOWN CHEMICALS.

⚠ WARNING: This product and the fuels used to operate this product (liquid propane), and the products of combustion of such fuels, can expose you to chemicals including benzene, which is known to the State of California to cause cancer and reproductive harm.

For more information go to www.p65Warnings.ca.gov

⚠ WARNING: Using this heater in a residential garage requires that the heater is positioned so that it is protected against any possible damage by a moving vehicle, etc. It must be positioned so that the base of the heater is no less than 18 in (450 mm) above the garage floor or 8 ft (2450 mm) in repair garages. The heater must be placed on a stable surface. Do not place it on a chair, ladder, etc. Raising the heater will reduce BUT NOT eliminate the possibility of lighting the vapor of any flammable liquids which may be improperly stored or accidentally spilled. If the smell of gasoline is present, DO NOT operate this heater until the area has been properly ventilated.

⚠ WARNING: CONSTRUCTION HEATERS ARE NOT FOR USE IN GARAGES IN CANADA.

⚠ WARNING: NOT FOR HOME OR RECREATIONAL VEHICLE USE.

NEVER LEAVE THE HEATER UNATTENDED WHILE BURNING!

PROPANE CONSTRUCTION HEATER



DYNA-GLO PROPANE FORCED AIR CONSTRUCTION HEATERS

The heater is designed and approved for use as a construction heater under ANSI Z83.7 CSA 2.14. It is hard to anticipate every use which may be made of this heater. **CHECK WITH YOUR LOCAL FIRE SAFETY AUTHORITY IF YOU HAVE QUESTIONS ABOUT APPLICATIONS.**

Other standards govern the use of fuel gases and heat producing products in specific applications. Your local authority can advise you about these.

IMPORTANT: READ THIS USER'S MANUAL CAREFULLY AND COMPLETELY BEFORE TRYING TO OPERATE OR SERVICE THIS HEATER. IMPROPER USE OF THIS HEATER CAN CAUSE SERIOUS INJURY OR DEATH FROM FIRE, EXPLOSION AND CARBON MONOXIDE POISONING.

This is a direct-fired forced air construction heater for either indoor construction or outdoor use. Its intended use is primarily the temporary heating of buildings or structures under construction, alteration or repair. All the products of combustion generated by the heater are forced through the heater and released into the area being heated. This heater operates at approximately 98%+ combustion efficiency but still produces a small amount of carbon monoxide. Humans can tolerate small amounts of carbon monoxide for short periods. Carbon monoxide can build up in a heated space and failure to provide adequate ventilation could result in poisoning or death.

For either indoor or outdoor use. Adequate ventilation shall be provided in accordance with OSHA 29 CFR 1926.154, Safety Requirements for Temporary and Portable Space Heating Devices and Equipment ANSI A10.10, ANSI 223.1 / NFPA 54, Liquefied Petroleum Gas Code, NFPA 58 or the National Gas and Propane Installation Code, CAN B149.1 as appropriate.

 **WARNING:** NOT FOR USE WITH DUCT WORK.

WARNING Air Quality Hazard

- Do not use this heater for heating human living quarters.
- Use of direct-fired heaters in the construction environment can result in exposure to levels of CO, CO₂, and NO₂ considered to be hazardous to health and potentially life threatening.
- Do not use in unventilated areas
- Know the signs of CO and CO₂ poisoning
 - Headaches, stinging eyes
 - Dizziness, disorientation
 - Difficulty breathing, feels of being suffocated
- Proper ventilation air exchange (OSHA 29 CFR 1926.57) to support combustion and maintain acceptable air quality shall be provided in accordance with OSHA 29 CFR Part 1926.154, ANSI A10.10 Safety Requirements for Temporary and Portable Space Heating Devices and Equipment used in the Construction Industry or the Natural Gas and Propane Installation Codes CSA B149.1
 - Periodically monitor levels of CO, CO₂ and NO₂ existing at the construction site – at the minimum at the start of the shift and after 4 hours.
 - Provide ventilation air exchange, either natural or mechanical, as required to maintain acceptable indoor air quality

**NEVER LEAVE THE HEATER
UNATTENDED WHILE BURNING!**



PROPANE CONSTRUCTION HEATER

USA 8-Hr Time weighted average
(OSHA 29 CFR 1926.55 App A)

Canada 8-hr time weighted average
WorkSafe BC OHS Guidelines Part 5.1
and Ontario Workplaces Reg 833

CO 50 ppm

25 ppm

CO₂ 5000 ppm

5000 ppm

NO₂

3 ppm (Reg 833)

USA – Ceiling Limit
(Short Term Exposure Limit = 15 minutes)

Canada STEL (15 minutes Reg 833/1 hour
WSBC) WorkSafe BC OHS Guidelines Part
5.1 and Ontario Workplaces Reg 833

CO

100 ppm

CO₂

15000 ppm (WSBC)
30000 ppm (Reg 833)

NO₂ 5 ppm

1.0 ppm (WorkSafeBC)
5.0 ppm (Reg 833)

- Ensure that the flow of combustion and ventilation air exchange cannot become obstructed.
- As the building ‘tightens up’ during the construction phases ventilation may need to be increased.

SPECIFICATIONS

Model No.		FA43 Series
Input Rating		37,000 BTU/hr (12.6 KW) Min. 43,000 BTU/hr (10.84 KW) Max.
Type of Gas		Propane
Gas Supply Pressure to Regulator Maximum		Cylinder Pressure
Minimum (for purpose of Input Adjustment)		5 psig
Manifold Pressure		11" W.C
Gas Consumption		1.71lbs/hr 0.78 kg/hr 2.00lbs/hr 0.91 kg/hr
Electrical Input		120V, 60Hz, 1Ø
Amperage	Load	1.75 amps
Fan	Unload Load	3375rpm 3100rpm
Ignition		Piezo/Manual Spark
Spark Gap		0.16" (4mm)
Size (LxWxH)		16.2"x8.3"x11.9" (41.2x21.1x30.2)cm

PROPANE CONSTRUCTION HEATER



GENERAL SAFETY INSTRUCTION

Accidents are always tragic especially because so many of them could have been prevented with little care and judgment. There are some basic good practices, we hope you will follow for safe use of your heater.

IMPORTANT SAFETY INSTRUCTION

- Children should be carefully supervised, when they are in the area.
- Always maintain proper clearance from combustible materials. Minimum clearance from combustibles: Side - 24" (61 cm); Top - 36" (92 cm); Front - 72" (183 cm). Floor - combustible. Not for use on finished floors.
- Heater must be placed on level and stable surface.
- Never place anything including clothes or other flammable items on the heater.
- The appliance area shall be kept clear and free from combustible materials, gasoline and other flammable vapours and liquids.
- Do not modify or operate a heater which has been modified.
- Adequate clearance for accessibility and for combustion & ventilation air supply must be maintained at all times when the heater is operating.
- Service and repair should be done by a qualified service person. The heater should be inspected before each use and at least annually by a qualified person. More frequent cleaning may be required as necessary. Do not service while hot or operating.
- Never connect heater to an unregulated gas supply.
- The heater is shipped from the factory for LP(Propane) gas. This heater is for use with propane gas only, do not convert heater to any other gas. Installation must conform to local codes or, in the absence of local codes, with the standard for the Storage and Handling of Liquefied Petroleum Gases ANSI/NFPA 58 and the Natural Gas and Propane Installation Code CSA B149.1
- The minimum and maximum inlet pressures to the regulator from the gas tank are 5 psi and bottle pressure, respectively. Use only the regulator & hose assembly provided with the heater. Inspect the regulator/hose assembly prior to each use of the heater. If there is excessive abrasion or wear, or hose is cut, replace with regulator/hose assembly listed on the parts list prior to using this heater.
- Gas supply connections should be checked using a 50/50 solution of liquid dish soap and never use a flame to check for gas leaks.
- The electrical connection & grounding must comply with National Electrical Code. ANSI/NFPA 70 or in Canada CSA C22.1, Canadian Electrical Code, Part 1. Use only a properly grounded three (3) prong receptacle.
- Do not restrict inlet or outlet by any means. The flow of combustion and ventilation air is not to be obstructed.
- This heater should not be directed toward any propane-gas container within 20 ft (6M). The heater must be located at least 6 ft. (1.83 m) in the U.S.; or (ii) 10 ft. (3 m) in Canada, from any propane gas container.
- The propane cylinder supply system must be arranged to provide for vapour withdrawal from the operating cylinder.
- This heater is not to be used with external thermostats, timers or other devices that control or alter electrical supply to the heater.
- Heater must be placed on a flat stable surface. Do not position the heater at any other angle than the intended design position. Certain models can change the up and down tilt angle by loosening the "height control screw" and moving the "height controller", then retightening the "height control screw".
- This heater is not designed to thaw ground surfaces.
- Installation of this Appliance at altitudes above 2000 ft. (610 m) shall be in accordance with local codes, or in the absence of local codes the, National Fuel Gas Code, ANSI Z223.1 / NFPA 54, or National Standard of Canada, Natural Gas and Propane Installation Code, CSA B149.1.

⚠ WARNING: Motor and fan must be running before lighting, during operation and at shutdown, in order to prevent a flame-out condition which could result in personal injury or property damage.

PRODUCT FEATURES

- Portable & Stable
- Wind Resistant & Rain Protected
- Piezo Electric Spark Ignition
- 100% Safety Shutoff System
- Continuous Adjustable Input Rating

**NEVER LEAVE THE HEATER
UNATTENDED WHILE BURNING!**



PROPANE CONSTRUCTION HEATER

UNPACKING HEATER

1. Remove heater from carton.
2. Remove all protective packing applied to heater for shipment.
3. Retain cartons and packaging material until unit is operated and found in good condition.
4. Check heater for any shipping damage. If heater shows any external or internal damage, promptly inform dealer/distributor where you purchased heater.

Assembly Components and Instructions for Steel Base Units:

Tools required for assembly:
All Models: Adjustable Wrench

Contents:
All Models: Unit, Manual, Hose and Regulator
Assembly

Assembly Time:
5 Minutes

Regulator and Hose Connection:

See figure on right.
Connect the hose tightly to
the heater using a wrench.
Please also refer to
page 7 in the manual.

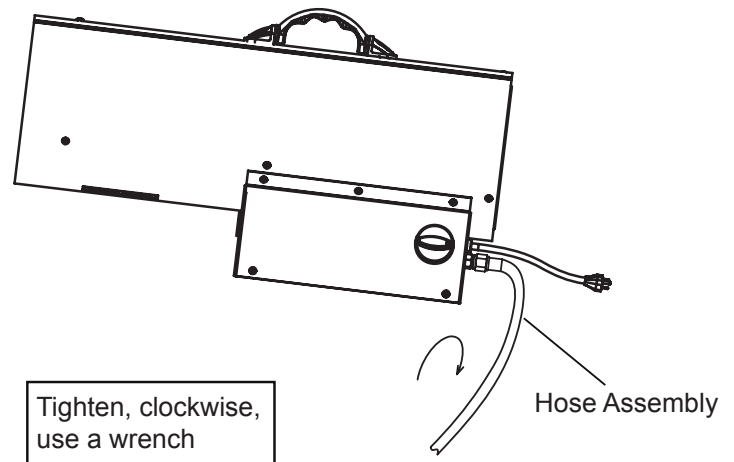

PROPANE CONSTRUCTION HEATER



INFORMATION ON SIZE * CAPACITY OF PROPANE GAS CYLINDERS:

The chart below shows the number and size of propane tanks needed to run this heater.

*Less gas is vaporized at lower temperatures.

You may need two or more 100 pound (45 kg) tanks or one larger tank in colder weather.

(See the parts list for your model of heater to get the specified regulator assembly.)

Temperature (°F-°C) at tank	Number of Tanks
	37,000-43,000 BTU/h
Above 32°F (0°C)	1 - 20lb (9kg)
32°F (0°C)	1 - 20lb (9kg)
20°F (-7°C)	1 - 20lb (9kg)
10°F (-12°C)	1 - 20lb (9kg)
-10°F (-23°C)	2 - 20lb (9kg)
-20°F (-29°C)	1 - 100lb (45kg)

The propane (LP) gas tank must also be equipped with the following:

- A collar to protect the Propane gas valve.
- A shutoff valve terminating a Propane gas cylinder valve outlet as specified in the American National Standards for Compressed Gas Cylinder Valve Outlets and Inlet Connections.
- A safety relief valve having direct communications with the vapor space of the tank.
- An arrangement of vapor withdrawal.

The propane (LP) gas pressure regulator and hose assembly supplied with this heater must be used without alteration.

The hose assembly shall be visually inspected prior to each use of the heater. If it is evident that there is excessive abrasion or wear, or the hose is cut, it must be replaced prior to the heater being put into operation. The replacement hose assembly shall be that specified by the manufacturer.

**NEVER LEAVE THE HEATER
UNATTENDED WHILE BURNING!**



PROPANE CONSTRUCTION HEATER

INSTALLATION TO THE PROPANE GAS TANK

IMPORTANT: You must use a propane/LP gas supply cylinder that is compatible with the connection device provided with the hose and regulator.

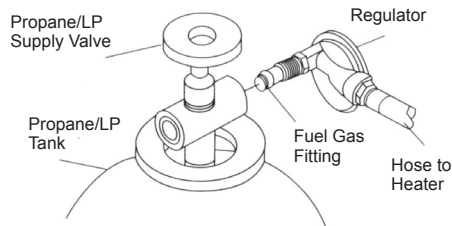

FIGURE 1

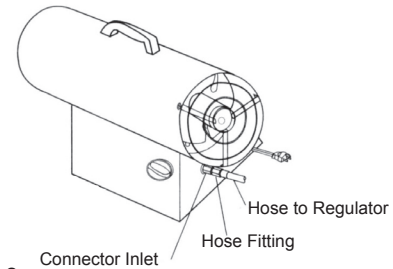

FIGURE 2

1. Provide propane/LP supply system. Ensure that the valve on the cylinder is fully closed by turning the knob fully clockwise (↻). Ensure that the cylinder is fully upright for vapor withdrawal. (see size/capacity, page 6).
2. Connect hose to heater inlet. Tighten firmly using a wrench. You must use the regulator supplied with heater.
3. Connect fuel gas fitting hose/regulator assembly to propane LP tank(s).
 - 3a. For units with a POL fitting (see figure 1) turn fuel fitting counterclockwise into threads on tank. Tighten firmly using a wrench. Some models have a hand wheel that can be used to tighten the fitting. This hand wheel can be slid off of the nut so that a wrench can also be used to tighten the fitting. **IMPORTANT:** Position regulator so that hose leaving the regulator is in a horizontal position.
4. Open propane/LP supply valve on propane/LP tank(s) slowly. NOTE: If not opened slowly, excess flow device in regulator may stop gas flow. If this happens, close propane/LP supply valve, wait one minute (or until you hear a click) and open again slowly.
5. Check all connections for leaks. Apply a 50/50 solution of liquid dish soap and water to gas joints. Bubbles forming show a leak that must be corrected before using the heater.
6. Close propane / LP supply valve before attempting to repair connection.



WARNING: Purging and filling of LP gas tanks must be performed by personnel who has been thoroughly trained in accepted LP gas industry procedures. Failure to follow these instructions may result in explosion, fire, severe personal injury, or death.

REFILLING THE PROPANE GAS TANK

ALL NEW CYLINDERS MUST BE PURGED BEFORE THE FIRST FILLING.

- Turn heater gas valve knob and gas tank valve to OFF position.
- Propane tank valve equipped with the old style fitting has LEFT HANDED THREADS. Turn POL fitting CLOCKWISE to loosen. Protect POL fitting when disconnected from tank.
- Have tank filled by your local Propane gas supplier.
- Fasten full Propane tank and connect POL fitting to tank valve by turning COUNTERCLOCKWISE.
- With heater gas valve knob still in the OFF position, turn ON tank valve and check for leaks with soap solution.

PROPANE CONSTRUCTION HEATER



PROPANE SAFETY

Propane is safe to use when properly handled. Careless handling of the Propane gas tank could result in fire and/or an explosion. Therefore:

- Always keep tank/cylinder securely fastened in an upright position.
- Avoid tipping tank on its side when connected to a regulator since this may cause damage to diaphragm in regulator.
- Handle valves with care.
- Never connect an unregulated Propane tank to construction heater.
- Do not subject Propane tank to excessive heat.
- Tightly close the gas shutoff valve on the Propane tank after each use.
- The POL fitting must be protected when disconnected from the propane tank.
- Never store a Propane gas tank inside a building or in the vicinity of any gas burning appliance.

THE DISCONNECTED TANK MUST NEVER BE STORED IN A BUILDING, GARAGE OR ANY OTHER ENCLOSED AREA.











LEAK CHECKING

Check all gas connections with a soap solution to be sure they are tight and leak proof (see page 7).

- The installation of your heater must meet all local codes and/or gas utility requirements or, in the absence of local codes, with the Storage and Handling of Liquefied Petroleum Gases, ANSI/ NFPA 58 and the Natural and Propane Installation Code, CSA B149.1.
- The minimum clearances to combustible construction: Side - 24" (61 cm); Top - 36" (92 cm); Front - 72" (183 cm); Floor - combustible, must be maintained at all times.
- The hose assembly should be visually inspected prior to each use of the heater. If it is evident that there is excessive abrasion or wear, or the hose is cut, it must be replaced prior to the heater being put into operation.
- The replacement hose assembly shall be that specified by the manufacturer (Refer to parts list).

LIGHTING INSTRUCTIONS

⚠ WARNING: Motor and fan must be running before lighting, during operation and shutdown, in order to prevent a flame-out condition which could result in personal injury or property damage.

1. Connect power cord to a properly grounded three (3) prong 120V, 60Hz, single phase receptacle.
2. Turn gas valve knob clockwise  to OFF  position.
3. Wait five (5) minutes to clear any gas. Then smell for gas, if you don't smell gas, go to next step.
4. Turn gas supply ON by turning Propane tank valve counterclockwise .
5. Push in and turn gas control knob counterclockwise  to "LOW  / IGN ". This will light the burner. Keep depressing and turning from OFF  to LOW  / IGN  until burner lights for FA43 manual piezo ignition systems.
6. Keep the valve knob depressed for at least 30 seconds after lighting the burner. After 30 seconds release valve knob.
7. If burner does not stay lit, repeat the lighting procedure.
8. When burner is lit, turn gas valve knob counterclockwise  to desired setting.

NEVER LEAVE THE HEATER UNATTENDED WHILE BURNING!



PROPANE CONSTRUCTION HEATER

SHUTDOWN INSTRUCTIONS

⚠ WARNING: Motor and fan must be running before lighting, during operation and at shutdown, in order to prevent a flame-out condition which could result in personal injury or property damage. Turn gas valve knob clockwise ↻ to OFF ○ position. Turn gas supply OFF by turning Propane tank valve clockwise ↻ to close. Disconnect the power cord once the heater has cooled to ambient temperature.

TEST FIRING HEATER

Test fire your construction heater, following the lighting instructions applicable to the gas control system employed. Leak test all gas connections with soap solution. Soap bubbles indicate gas leakage. DO NOT use a match or flame to test for gas leaks.

STORAGE

Never store a Propane gas tank inside a building or in the vicinity of any gas or oil burning appliance. When the Propane tank is not disconnected from the construction heater, the gas tank and heater must be stored outdoors in a well ventilated area, out of the reach of children. If for any reason the heater is to be stored indoors, the tank must be disconnected and stored outdoors in a well ventilated area out of reach of children, in accordance with the standard for the the Storage and Handling of Liquefied Petroleum Gases, ANSI / NFPA 58 and CSA B149.1, Natural Gas and Propane Installation Code. The plastic tank valve plug supplied with your tank must be tightly installed when the tank is disconnected from the heater.

MAINTENANCE INSTRUCTIONS

1. Turn unit off, allow heater to fully cool and disconnect propane hose before performing any Maintenance functions. Unplug the unit from the 120V receptacle.
2. Keep unit clean and keep the inside of the torpedo housing debris free so that ventilation and combustion air is not obstructed.
3. Have unit checked by a qualified service technician at least once a year, preferably prior to the heating season.

REPLACEMENT PARTS

Warning: Use only original replacement parts. This Heater must use design-specific parts. Do not substitute or use generic parts. Improper replacement parts could cause serious or fatal injuries.

This will also protect your warranty coverage for parts replaced under warranty.

Parts warranty and non-warranty: Contact authorized dealers of this product. If they can not supply original replacement part(s), either contact your nearest Parts Central or GHP Group Inc., Technical Service Department at 1-877-447-4768.

When calling GHP Group Inc., have ready:

- your name
- your address
- how heater was malfunctioning
- serial number of heater
- model number of heater
- replacement part number

PROPANE CONSTRUCTION HEATER



TROUBLESHOOTING

PROBLEM	POSSIBLE CAUSE	CORRECTIVE ACTION
1. Fan does not turn when electrical connection is made.	<ol style="list-style-type: none">1. No electric power to heater.2. Fan blade contacts inside of heater housing.3. Fan blade(s) bent4. Fan motor defective.	<ol style="list-style-type: none">1. Check current to electric outlet. If voltage is correct, check power cord and extension cord for2. Be sure that housing is not damaged. Make sure there are no obstructions to the fan.3. Straighten blade(s) to match others.4. Replace motor.
2. Heater will not fire.	<ol style="list-style-type: none">1. No spark at ignitor.2. Improper spark gap.3. Bad electrode.	<ol style="list-style-type: none">1. Check ignitor wire. Re-attach or tighten if loose. Check Spark module. Replace if necessary.2. Set gap (See specifications for gap).3. Replace spark electrode.
3. Heater quits while running.	<ol style="list-style-type: none">1. Internal temperature too high causing limit switch to shut down operation.2. Damaged Control Valve.3. Dust or debris build-up inside of heater.	<ol style="list-style-type: none">1. If the heaters output is restricted, internal temperature becomes too high. Move heater away from any obstructions.2. Replace Control Valve.3. Clean inside of heater.

Always be sure to follow proper maintenance procedures, by cleaning the heater once per month during regular usage, and check spark gap at least once per season.

**NEVER LEAVE THE HEATER
UNATTENDED WHILE BURNING!**



PROPANE CONSTRUCTION HEATER

WIRING DIAGRAM

WIRING DIAGRAM

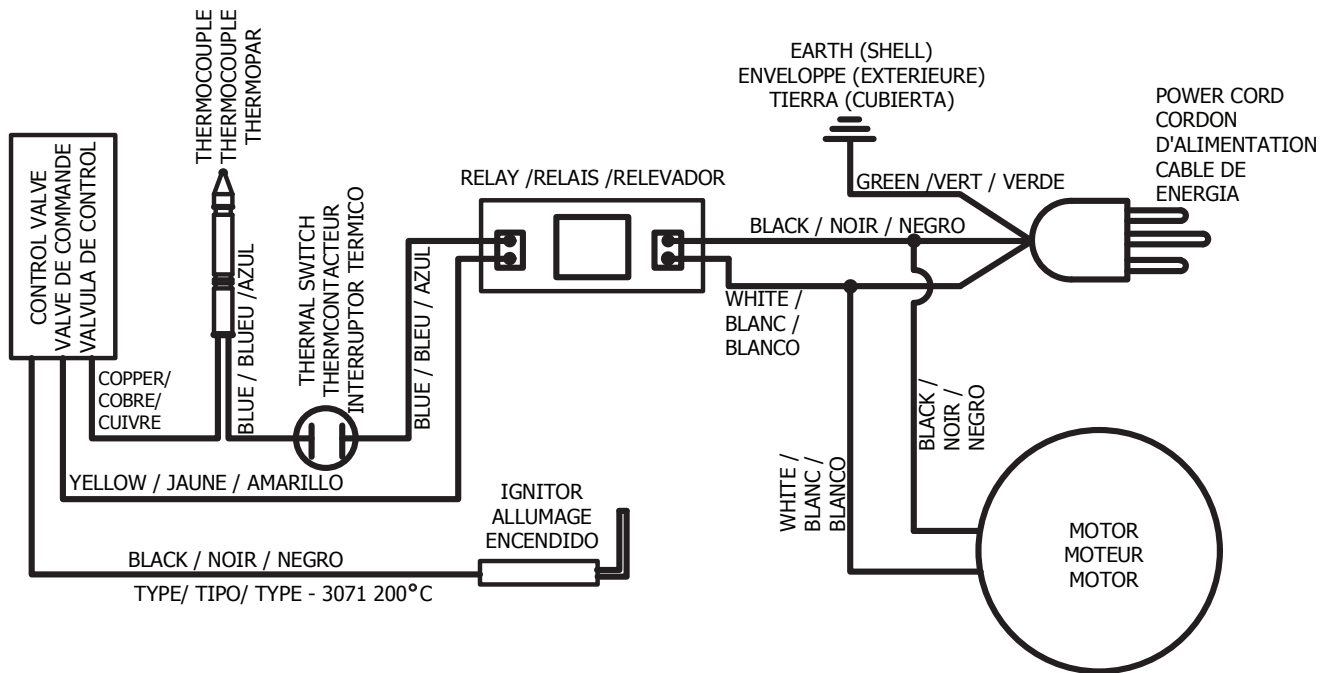

IF ANY ORIGINAL WIRING SUPPLIED WITH THIS HEATER MUST BE REPLACED, IT MUST BE TYPE AWG 105C WIRE OR ITS EQUIVALENT EXCEPT AS INDICATED.

SI SE DEBE REEMPLAZAR UN CABLEADO ORIGINAL PROVIEIDO CON EL CALENTADOR, DEBE SER CABLE TIPO AWG 105C O SU EQUIVALENTE, EXCEPTO SI SE INDICA DE OTRA MANERA.

SI VOUS DEVEZZ FAIRE REMPLCER LES FILS D'ORIGINE DU RADIATEUR, PROCUREZ-VOUS DU FIL AWG 105C OU L'EQUIVALENT SAUF INDICATION CONTRAIRE.

WDLPF43_KCH_2018-03-08

PROPANE CONSTRUCTION HEATER



REPLACEMENT PARTS LIST

MODEL: FA43 Series

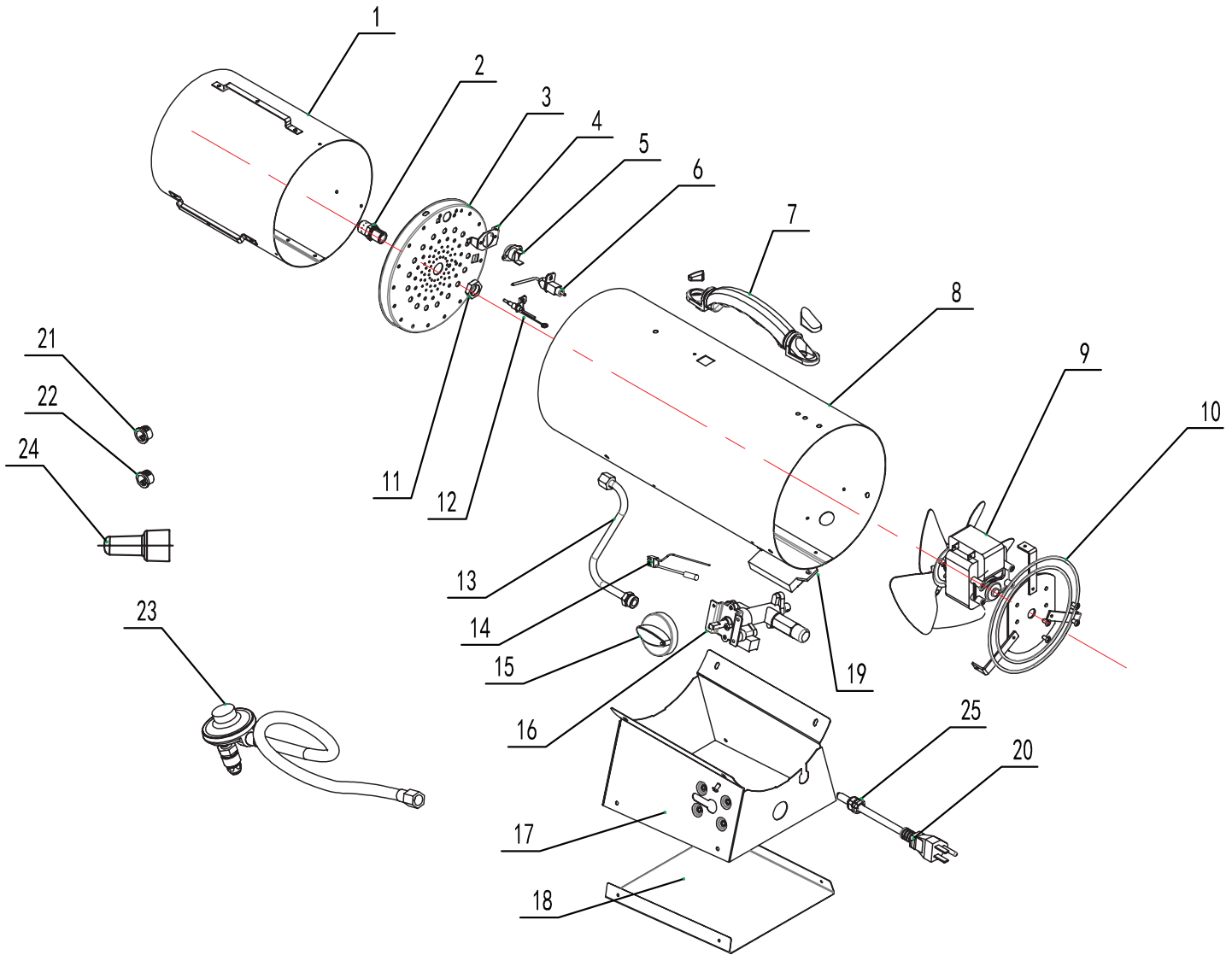

**NEVER LEAVE THE HEATER
UNATTENDED WHILE BURNING!**



PROPANE CONSTRUCTION HEATER

REPLACEMENT PARTS LIST

Article No.	DESCRIPTION	QTY	PART NUMBER
			43 SERIES
1	INNER SHELL ASSEMBLY	1	FA43-CR-02
2	NOZZLE	1	FA43-CR-08
3	FLAME CAP	1	FA43-CR-09
4	THERMAL SWITCH BRACKET	1	2304826
5	THERMAL SWITCH	1	2201373
6	SPARK ELECTRODE	1	2201375
7	HANDLE ASSEMBLY (BLACK)	1	2101447
	HANDLE ASSEMBLY (GRAY)	1	2305426
8	OUTER SHELL (BLACK)	1	FA43-CR-01
	OUTER SHELL (ORANGE)	1	FA43-CR-01(O)
	OUTER SHELL (GRAY)	1	FA43-CR-01(G)
	OUTER SHELL (BLUE)	1	FA43-CR-01(B)
9	MOTOR ASSEMBLY	1	FA43-CR-05
10	REAR GUARD (BLACK)	1	FA43-CR-06
	REAR GUARD (GRAY)	1	FA43-CR-06(G)
11	NOZZLE NUT	1	2304578
12	THERMOCOUPLE	1	2304885
13	GAS TUBING ASSEMBLY	1	FA43-CR-11
14	WIRE	1	2201371
15	CONTROL KNOB (BLACK)	1	2101451
	CONTROL KNOB (ORANGE)	1	2305466
16	VALVE	1	GS22-FA43
17	BASE ASSEMBLY (BLACK)	1	FA43-CR-07
	BASE ASSEMBLY (GRAY)	1	FA43-CR-07(G)
18	BASE LOWER (BLACK)	1	FA43-CR-10
	BASE LOWER (GREY)	1	FA43-CR-10(G)
19	PCB ASSEMBLY	1	2201369
20	POWER CORD	1	FA43-CR-14
21	GROMMET	1	2315496
22	GROMMET	1	2315497
23	REGULATOR, L=3050MM	1	GR-129B-01(3050)
	REGULATOR, L=4600MM	1	GR-129B-01(4600)
24	CLOSED END SPLICE	1	FA43-CR-13
25	STRAIN RELIEF	1	2315495

Replacement parts available at GHP Group Inc. Call Customer Service Dept. at 877-447-4768 or email us at customerservice@ghpgroupinc.com.

WARRANTY

LIMITED WARRANTY:

This limited warranty is extended to the original retail purchaser of this Forced Air/Convection/Radiant Heater and warrants against any defect in materials and workmanship for a period of one (1) year from the date of retail sale (lifetime warranty for the brass nozzle burner only). GHP Group, Inc., at its option, will either provide replacement parts or replace or repair the unit, when properly returned to the retailer where purchased or one of our service centers as directed by GHP Group, Inc., within one (1) year of retail purchase. (Shipping costs, labour costs, etc. are the responsibility of the purchaser.)

DUTIES OF THE OWNER:

This heating appliance must be operated in accordance with the written instructions furnished with this heater. This warranty shall not excuse the owner from properly maintaining this heater in accordance with the written instructions furnished with this heater. A bill of sale, canceled check or payment record must be kept to verify purchase date and establish warranty period. Original carton should be kept in case of warranty return of unit.

WHAT IS NOT COVERED:

1. Damage resulting from use of improper fuel.
2. Damage caused by misuse or use contrary to the owners manual and safety guidelines.
3. Damage caused by a lack of normal maintenance.
4. Fuses
5. Use of non-standard parts or accessories.
6. Damage caused in transit. Freight charges on warranty parts or heaters to and from the factory shall be the responsibility of the owner.

This warranty does not imply or assume any responsibility for consequential damages that may result from the use, misuse, or the lack of routine maintenance of this heating appliance. A cleaning fee and the cost of parts may be charged for appliance failures resulting from lack of maintenance. This warranty does not cover claims which do not involve defective workmanship or materials. **FAILURE TO PERFORM GENERAL MAINTENANCE (INCLUDING CLEANING) WILL VOID THIS WARRANTY.**

THIS LIMITED WARRANTY IS GIVEN TO THE PURCHASER IN LIEU OF ALL OTHER WARRANTIES, EXPRESSED OR IMPLIED, INCLUDING BUT NOT LIMITED TO THE WARRANTIES OF MERCHANTABILITY OF FITNESS FOR A PARTICULAR PURPOSE. THE REMEDY PROVIDED IN THIS WARRANTY IS EXCLUSIVE AND IS GRANTED IN LIEU OF ALL OTHER REMEDIES. IN NO EVENT WILL GHP GROUP, INC. BE LIABLE FOR INCIDENTAL OR CONSEQUENTIAL DAMAGES.

Some states do not allow limitations on how long an implied warranty lasts, so the above limitation may not apply to you. Some states do not allow the exclusion or limitation of incidental or consequential damages so the above limitation or exclusion may not apply to you.

CLAIMS HANDLED AS FOLLOWS:

1. Contact your retailer and explain the problem.
2. If the retailer is unable to resolve the problem, contact our Customer Service Dept. detailing the heater model, the problem, and proof of date of purchase.
3. A representative will contact you. DO NOT RETURN THE HEATER TO GHP GROUP, INC. unless instructed by our Representative. This warranty gives you specific legal rights and you may also have other rights which vary from state to state.

TO REGISTER THE WARRANTY ON YOUR HEATER, PLEASE FILL OUT THIS CARD COMPLETELY
AND MAIL WITHIN 14 DAYS FROM DATE OF PURCHASE OR REGISTER ON-LINE AT www.ghpgroupinc.com

NAME: _____ PHONE: () _____ EMAIL: _____
ADDRESS: _____ CITY: _____ STATE: _____ ZIP: _____
MODEL: _____ SERIAL #: _____ DATE PURCHASED: _____
DEALER PURCHASED FROM: _____ TYPE OF STORE: _____
CITY & STATE WHERE PURCHASED: _____ PRICE PAID: _____

Please Take a Minute To Give Us Your Answers To The Following Questions.

All Responses Are Used Solely For Market Research And Are Held In Strict Confidence.

Who primarily decided this purchase? Male Female 18-24 25-39 40-59 60 and over

Purpose of Purchase? _____

Do you own any other portable heaters? Yes No If yes, type _____ brand _____

How do you intend to use your new heater? Construction Site Farm Warehouse/Commercial Garage/Outbuilding Other

How did you become aware of this heater? In-Store Display Newspaper Ad Magazine Ad Friend/Relative

TV Commercial Store Salesperson Other _____

What made you select this heater? Style Size/Portability Price Package Brand Other _____

Do you: own rent Would you recommend this heater to a friend? Yes No

Please give us your comments: _____

THANK YOU FOR COMPLETING THIS FORM!

Information will be held confidential.

WARRANTY REGISTRATION

IMPORTANT: We urge you to fill out your warranty registration card within fourteen (14) days of date of purchase. You can also register your warranty on the internet at www.ghpgroupinc.com. Complete the entire serial number. Retain this portion of the card for your records.



GHP Group, Inc.
6440 W Howard St
Niles, IL 60714-3302

Tel: (877) 447-4768
www.ghpgroupinc.com

SAVE THIS CARD!

Place
Postage
Stamp
Here

GHP Group, Inc.
6440 W Howard St
Niles, IL 60714-3302